

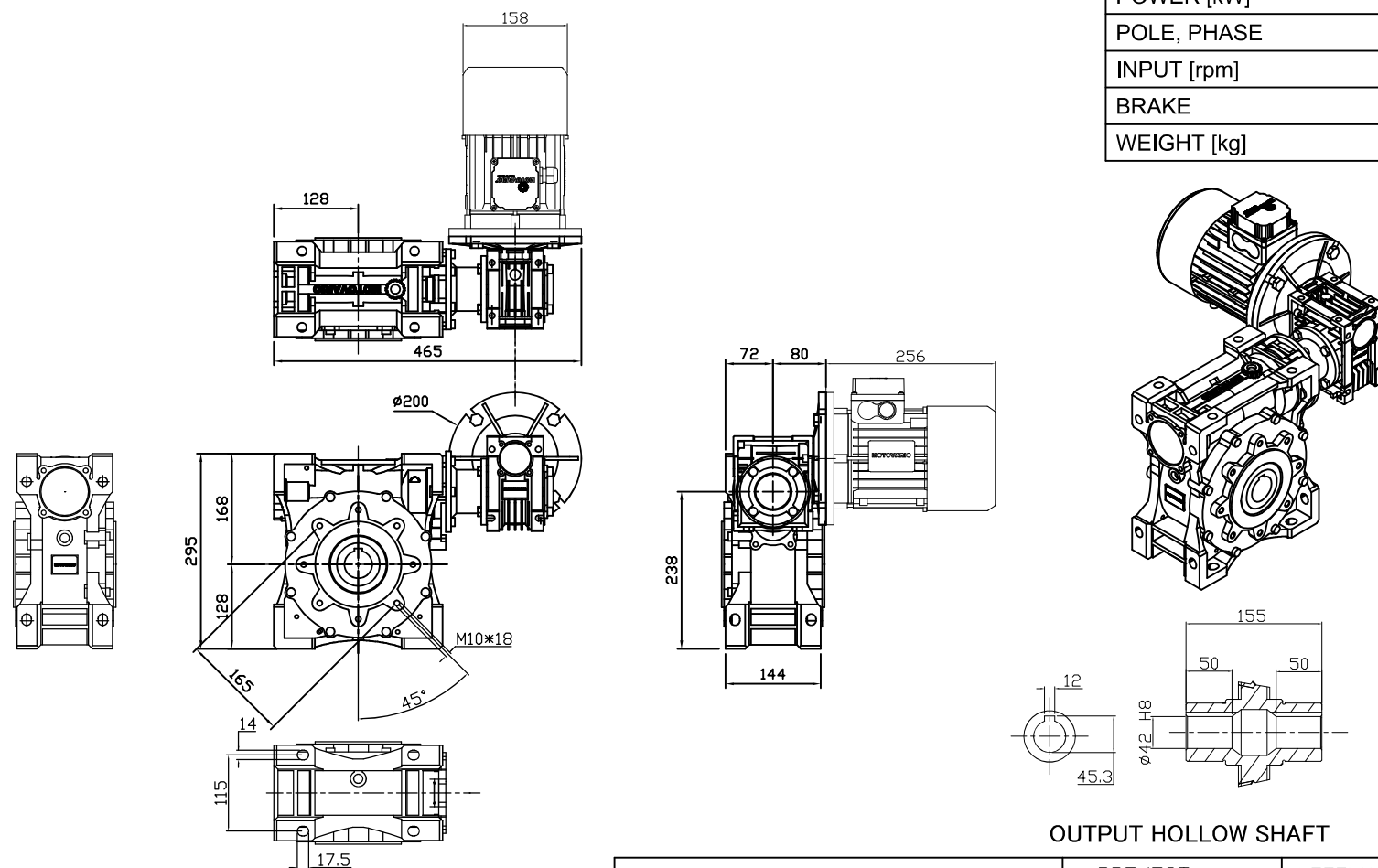

REDUCER SPEC	
MODEL	NMRV-P050/110
SERVICE FACTOR	2.1
RATIO	150
OUTPUT [rpm]	11.7
OUTPUT TORQUE [Nm]	422
WEIGHT [kg]	38.5

MOTOR SPEC	
MODEL	TPA/80B5 220/380V
POWER [kW]	0.75
POLE, PHASE	4P, 3PHASE
INPUT [rpm]	1750
BRAKE	NO
WEIGHT [kg]	13.2



OUTPUT HOLLOW SHAFT

 (주)한국체인모터 Tel. 032-815-8888 Fax. 815-8020 www.hcmfa.com	PROJECT		MOTOVARIO				
	DRAWN	SEO Y.S	DATE	REV	A	SCALE	1:1
	CHECKED	KIM J.S	DATE	UNIT	MM	PAGE	-
APPROVED	LEE J.Y	DATE	