

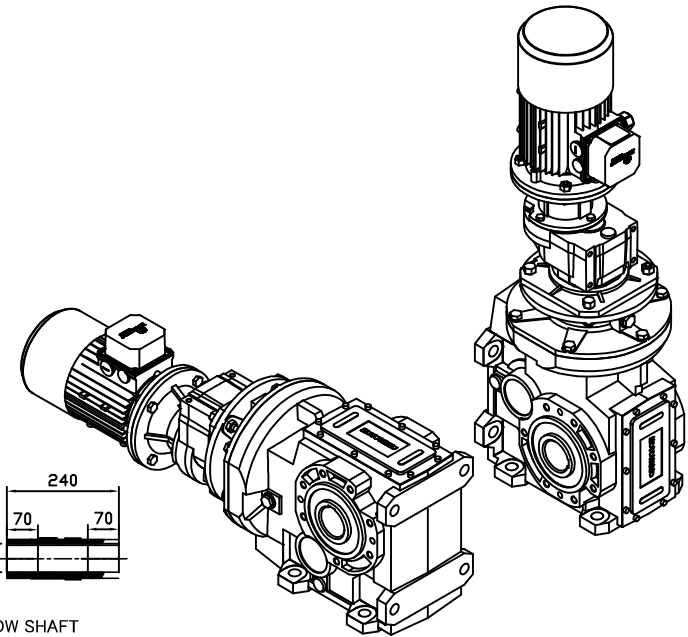

APPROX WEIGHT : 85+15+19.7 = 119.7 kg

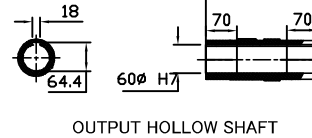
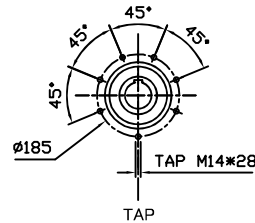
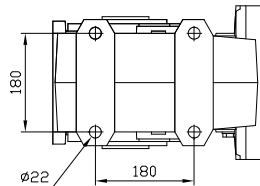
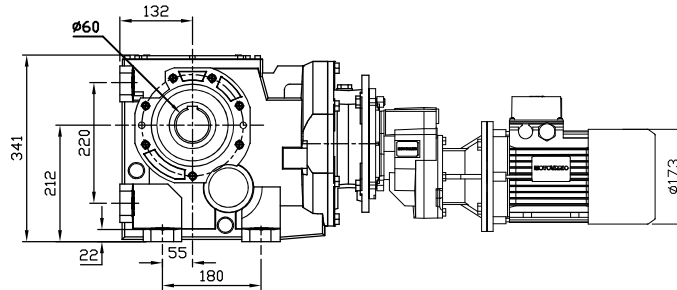
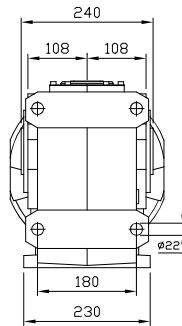
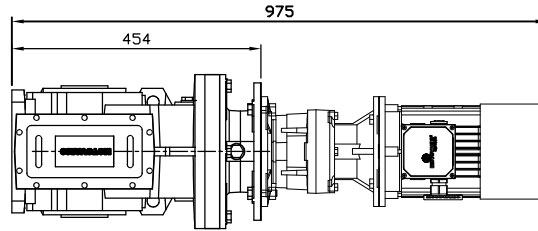

REDUCER SPEC	
MODEL	HR061+B123
SERVICE FACTOR	
RATIO	341.29
OUTPUT [rpm]	5.1
OUTPUT TORQUE [Nm]	2431
WEIGHT [kg]	100

MOTOR SPEC	
MODEL	TPA/90B5 220/380V
POWER [kW]	1.5
POLE, PHASE	4P, 3PHASE
INPUT [rpm]	1750
BRAKE	NO
WEIGHT [kg]	19.7

**(주)한국체인모터**

Tel. 032-815-8888 Fax. 815-8020  
www.hcmfa.com

PROJECT		MOTOVARIO					
DRAWN	SEO Y.S	DATE		REV	A	SCALE	1:1
CHECKED	KIM J.S	DATE		UNIT	MM	PAGE	-
APPROVED	LEE J.Y	DATE					