

REDUCER SPEC	
MODEL	NMRV-P040/090
SERVICE FACTOR	2.9
RATIO	400
OUTPUT [rpm]	4.2
OUTPUT TORQUE [Nm]	207
WEIGHT [kg]	15.3

MOTOR SPEC	
MODEL	TA/63B5-220/380V
POWER [kW]	0.18
POLE, PHASE	4P, 3PHASE
INPUT [rpm]	1680
BRAKE	NO
WEIGHT [kg]	4.2

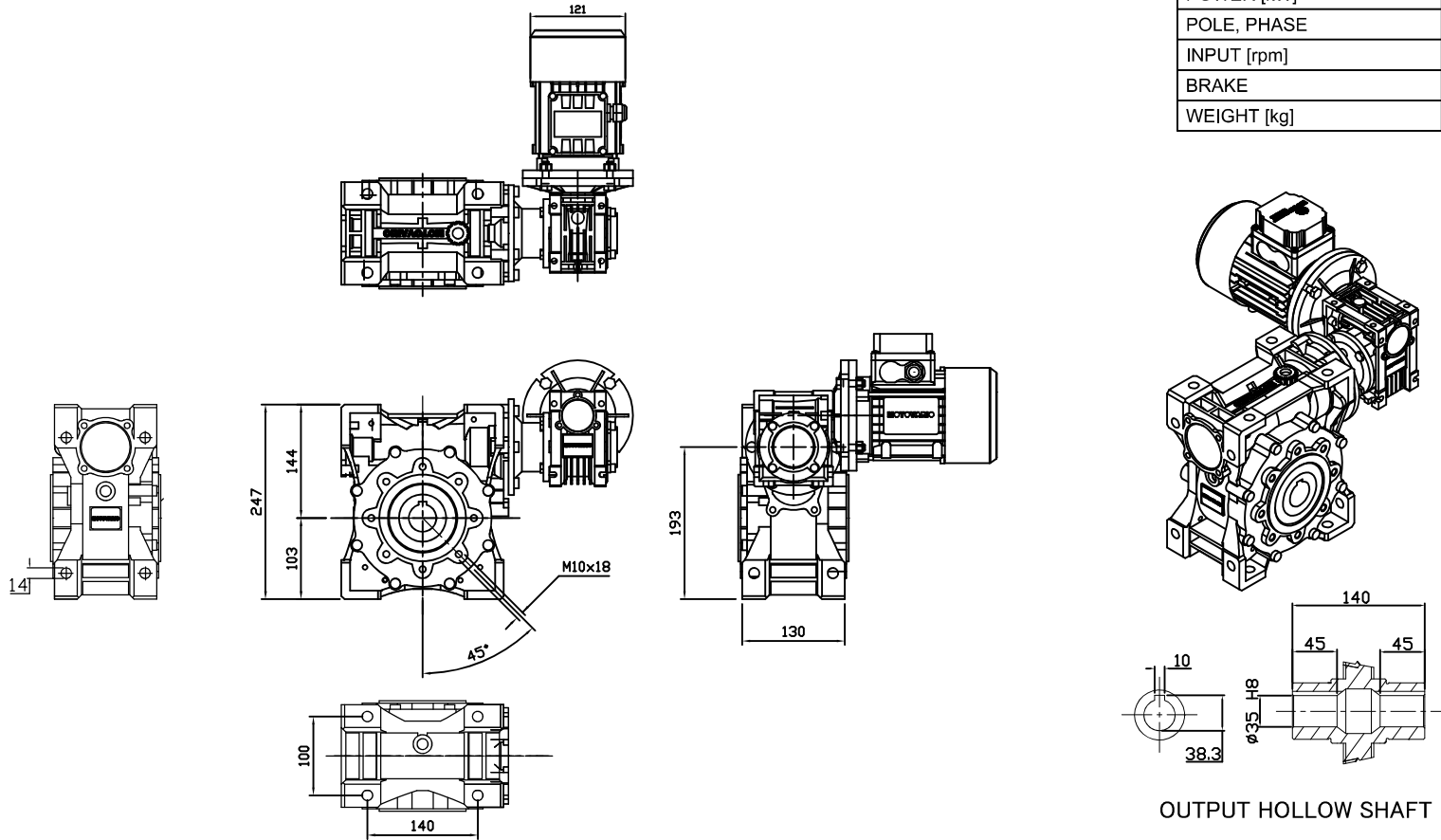

OUTPUT HOLLOW SHAFT

한국 (주)한국체인모터

Tel. 032-815-8888 Fax. 815-8020
www.hcmfa.com

PROJECT		MOTOVARIO					
DRAWN	SEO Y.S	DATE		REV	A	SCALE	1:1
CHECKED	KIM J.S	DATE		UNIT	MM	PAGE	-
APPROVED	LEE J.Y	DATE					